

# 2.048V Radiation Hardened Ultra Low Noise, Precision Voltage Reference

## ISL71091SEH20

The ISL71091SEH20 is an ultra low noise, high DC accuracy precision voltage reference with a wide input voltage range from 4.2V to 30V. It uses Intersil's Advanced Bipolar technology to achieve  $3.8\mu\text{V}_{\text{P-P}}$  0.1Hz to 10Hz noise with an initial voltage accuracy of 0.05%.

The ISL71091SEH20 offers a 2.048V output voltage option with 6ppm/°C temperature coefficient and also provides excellent line and load regulation. The device is offered in an 8 Ld Flatpack package.

The ISL71091SEH20 is ideal for high-end instrumentation, data acquisition and processing applications requiring high DC precision where low noise performance is critical.

### Applications

- Precision voltage sources for data acquisition system for space application
- Strain and pressure gauge for space applications
- Radiation hardened PWM requiring precision outputs

### Features

- Reference output voltage .....  $2.048\text{V} \pm 0.05\%$
- Accuracy over temperature .....  $\pm 0.15\%$
- Accuracy over radiation .....  $\pm 0.25\%$
- Output voltage noise .....  $3.8\mu\text{V}_{\text{P-P}}$  typ (0.1Hz to 10Hz)
- Supply current ..... 300µA (Typ)
- $V_{\text{OS}}$  temperature coefficient ..... 6ppm/°C Max
- Output current capability ..... 10mA/-5mA
- Line regulation ..... 5ppm/V Max.
- Load regulation (Sourcing) ..... 40ppm/mA Max.
- Operating temperature range ..... -55°C to +125°C
- Radiation environment
  - High dose rate (50 to 300rad(Si)/s) ..... 100krad(Si)
  - Low dose rate (0.01rad(Si)/s) ..... 100krad(Si)\*
  - SEL/SEB free ( $V_{\text{CC}} = 36\text{V}$ ) .....  $86\text{MeV} \cdot \text{cm}^2/\text{mg}$

\*Product capability established by initial characterization. The "EH" version is acceptance tested on a wafer-by-wafer basis to 50krad(Si) at low dose rate.

- Electrically screened to SMD 5962-14208

### Related Literature

- [AN1906](#), "ISL71091SEHXXEV1Z User's Guide"
- [AN1938](#), "SEE Testing of the ISL71091SEH"
- [AN1939](#), "Radiation Report of the ISL71091SEH"

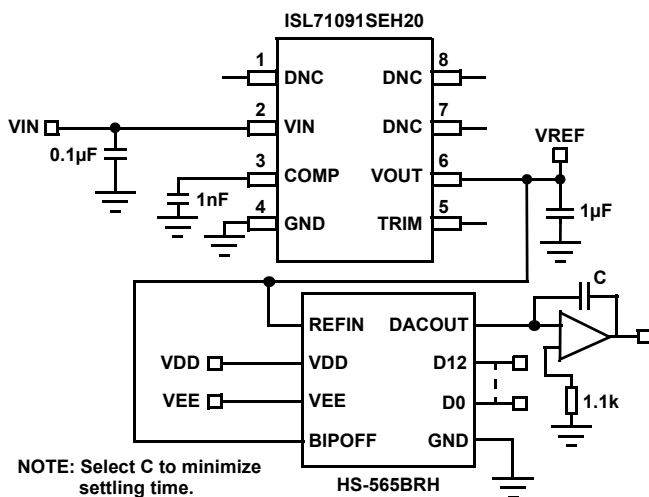

FIGURE 1. ISL71091SEH20 TYPICAL APPLICATION DIAGRAM

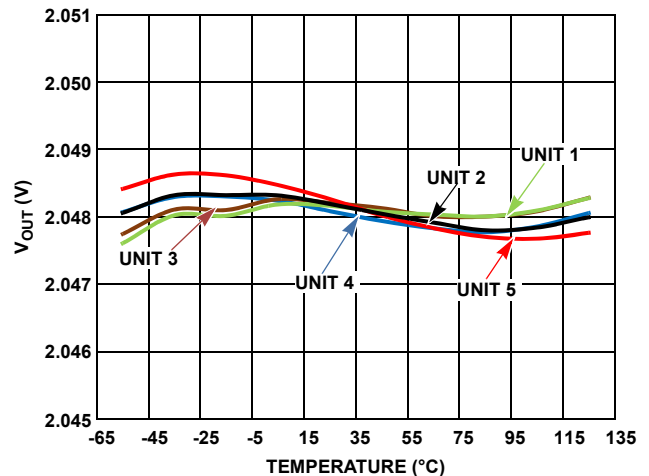

FIGURE 2.  $V_{\text{OUT}}$  vs TEMPERATURE

# ISL71091SEH20

## Ordering Information

ORDERING NUMBER (Notes 1, 2)	PART NUMBER	V <sub>OUT</sub> OPTION (Note 3) (V)	GRADE (%)	TEMPCO (ppm/°C)	TEMP RANGE (°C)	PACKAGE (RoHS Compliant)	PKG. DWG. #
5962R1420801VXC	ISL71091SEHVF20	2.048	0.05	6	-55 to +125	8 Ld Flatpack	K8.A
5962R1420801V9A	ISL71091SEHVX20	2.048	0.05	6	-55 to +125	Die	
ISL71091SEHF20/PROTO	ISL71091SEHF20/PROTO	2.048	0.05	6	-55 to +125	8 Ld Flatpack	K8.A
ISL71091SEHF20SAMPLE	ISL71091SEHX20SAMPLE	2.048	0.05	6	-55 to +125	Die	
ISL71091SEH20EV1Z	Evaluation Board						

### NOTES:

- These Intersil Pb-free Hermetic packaged products employ 100% Au plate - e4 termination finish, which is RoHS compliant and compatible with both SnPb and Pb-free soldering operations.
- Specifications for Rad Hard QML devices are controlled by the Defense Logistics Agency Land and Maritime (DLA). The SMD numbers listed in the "Ordering Information" table must be used when ordering.
- For alternate V<sub>OUT</sub> options, visit the ISL71090SEH and ISL71091SEH family pages.

## Pin Configuration

ISL71091SEH20  
(8 LD FLATPACK)  
TOP VIEW

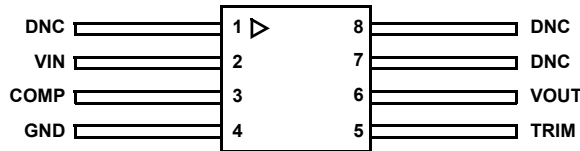

NOTE: The ESD triangular mark is indicative of pin #1. It is a part of the device marking and is placed on the lid in the quadrant where pin #1 is located.

## Pin Descriptions

PIN NUMBER	PIN NAME	ESD CIRCUIT	DESCRIPTION
1, 7, 8	DNC	3	Do not connect. Internally terminated.
2	VIN	1	Input voltage connection.
3	COMP	2	Compensation and noise reduction capacitor.
4	GND	1	Ground connection. Also connected to the lid.
5	TRIM	2	Voltage reference trim input.
6	VOUT	2	Voltage reference output.

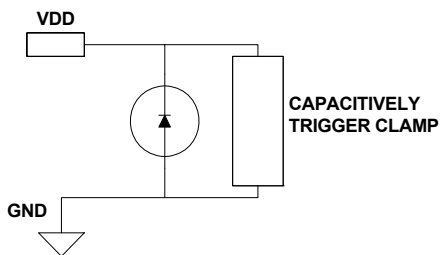

ESD CIRCUIT 1

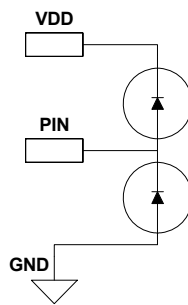

ESD CIRCUIT 2

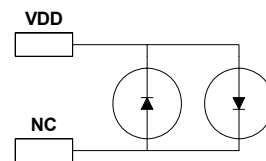

ESD CIRCUIT 3

# ISL71091SEH20

## Functional Block Diagram

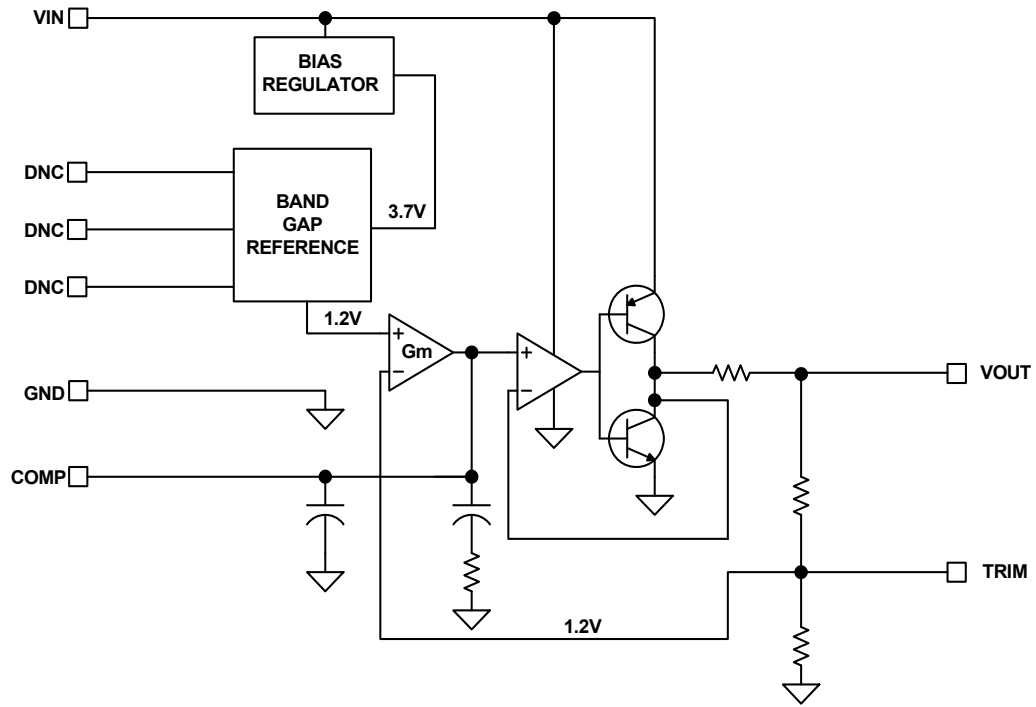

## Typical Trim Application Diagram

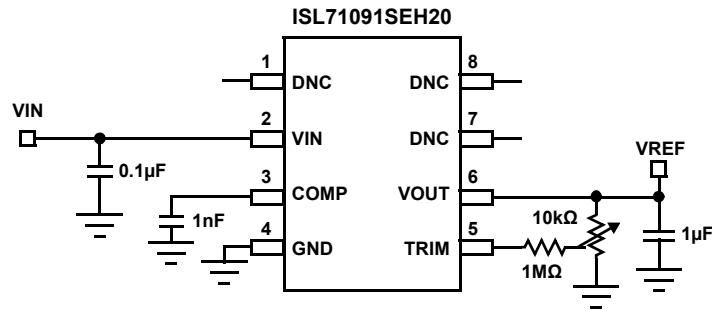

# ISL71091SEH20

## Absolute Maximum Ratings

Max Voltage	
$V_{IN}$ to GND	-0.5V to +40V
$V_{IN}$ to GND at an LET = 86MeV.cm <sup>2</sup> /mg	-0.5V to +36V
$V_{OUT}$ to GND (10s)	-0.5V to $V_{OUT} + 0.5V$
Voltage on any Pin to Ground	-0.5V to $V_{OUT} + 0.5V$
Voltage on DNC Pins	No connections permitted to these pins
ESD Ratings (MIL STD 883 Method)	
Human Body Model	2kV
Machine Model	200V
Charged Device Model	750V

## Thermal Information

Thermal Resistance (Typical)	$\theta_{JA}$ (°C/W)	$\theta_{JC}$ (°C/W)
8 Ld Flatpack Package (Notes 4, 5)	135	11
Storage Temperature Range	-65°C to +150°C	
Maximum Junction Temperature ( $T_{JMAX}$ )	+150°C	
Pb-Free Reflow Profile	see <a href="#">TB493</a>	

## Recommended Operating Conditions

Input Voltage Range	+4.2V to +30V
Ambient Operating Temperature Range	-55°C to +125°C

**CAUTION:** Do not operate at or near the maximum ratings listed for extended periods of time. Exposure to such conditions may adversely impact product reliability and result in failures not covered by warranty.

### NOTES:

- $\theta_{JA}$  is measured with the component mounted on a high effective thermal conductivity test board in free air. See Tech Brief [TB379](#) for details.
- For  $\theta_{JC}$ , the "case temp" location is the center of the ceramic on the package underside.
- Post-reflow drift for the ISL71091SEH20 devices can exceed 100 $\mu$ V based on experimental results with devices on FR4 double sided boards. The engineer must take this into account when considering the reference voltage after assembly.

**Electrical Specifications for Flatpack**  $V_{IN} = 5V$ ,  $I_{OUT} = 0mA$ ,  $C_L = 1\mu F$  and  $C_{COMP} = 0.001\mu F$  unless otherwise specified. **Boldface limits apply across radiation and the operating temperature range, -55°C to +125°C.**

PARAMETER	DESCRIPTION	TEST CONDITIONS	MIN (Note 7)	TYP	MAX (Note 7)	UNITS
$V_{OUT}$	Output Voltage			2.048		V
$V_{OA}$	$V_{OUT}$ Accuracy at $T_A = +25^\circ C$	$V_{OUT} = 2.048V$ (Note 10)	-0.05		+0.05	%
$V_{OA}$	$V_{OUT}$ Accuracy at $T_A = -55^\circ C$ to $+125^\circ C$	$V_{OUT} = 2.048V$ (Note 10)	-0.15		+0.15	%
$V_{OA}$	$V_{OUT}$ Accuracy at $T_A = 25^\circ C$ , Post Rad	$V_{OUT} = 2.048V$ (Note 10)	-0.25		+0.25	%
TC $V_{OUT}$	Output Voltage Temperature Coefficient (Note 8)				<b>6</b>	ppm/°C
$V_{IN}$	Input Voltage Range	$V_{OUT} = 2.048V$	<b>4.2</b>		<b>30</b>	V
$I_{IN}$	Supply Current			0.3	<b>0.5</b>	mA
$\Delta V_{OUT}/\Delta V_{IN}$	Line Regulation	$V_{IN} = 4.2V$ to $30V$ , $V_{OUT} = 2.048V$		0.3	<b>5</b>	ppm/V
$\Delta V_{OUT}/\Delta I_{OUT}$	Load Regulation	Sourcing: $0mA \leq I_{OUT} \leq 10mA$		11	<b>40</b>	ppm/mA
		Sinking: $-5mA \leq I_{OUT} \leq 0mA$		25	<b>80</b>	ppm/mA
$V_D$	Dropout Voltage (Note 9)	$I_{OUT} = 10mA$		2	<b>2.5</b>	V
$I_{SC+}$	Short Circuit Current	$T_A = +25^\circ C$ , $V_{OUT}$ tied to GND		55		mA
$I_{SC-}$	Short Circuit Current	$T_A = +25^\circ C$ , $V_{OUT}$ tied to $V_{IN}$		-61		mA
$t_R$	Turn-on Settling Time	90% of final value, $C_L = 1.0\mu F$ , $C_C = 1000pF$		344		$\mu s$
PSRR	Ripple Rejection	$f = 120Hz$		90		dB
$e_N V_{P-P}$	Output Voltage Noise	$0.1Hz \leq f \leq 10Hz$ , $V_{OUT} = 2.048V$		3.8		$\mu V_{P-P}$
$e_N V_{RMS}$	Broadband Voltage Noise	$10Hz \leq f \leq 1kHz$ , $V_{OUT} = 2.048V$		3.4		$\mu V_{RMS}$
$e_N$	Noise Density	$f = 1kHz$ , $V_{OUT} = 2.048V$		91		nV/ $\sqrt{Hz}$
$\Delta V_{OUT}/\Delta t$	Long Term Stability	$T_A = +25^\circ C$ , 1000 hours		20		ppm

# ISL71091SEH20

**Electrical Specifications for Die**  $V_{IN} = 5V$ ,  $I_{OUT} = 0$ ,  $C_L = 1\mu F$  and  $C_{COMP} = 0.001\mu F$  unless otherwise specified. **Boldface limits apply across radiation and the operating temperature range, -55°C to +125°C. Specifications over temperature are guaranteed but not production tested on die.**

PARAMETER	DESCRIPTION	CONDITIONS	MIN ( <a href="#">Note 7</a> )	TYP	MAX ( <a href="#">Note 7</a> )	UNIT
$V_{OUT}$	Output Voltage			2.048		V
$V_{OA}$	$V_{OUT}$ Accuracy at $T_A = +25^\circ C$	$V_{OUT} = 2.048V$ ( <a href="#">Note 10</a> )	-0.05		+0.05	%
$V_{OA}$	$V_{OUT}$ Accuracy at $T_A = -55^\circ C$ to $+125^\circ C$	$V_{OUT} = 2.048V$ ( <a href="#">Note 10</a> )	-0.15		+0.15	%
$V_{OA}$	$V_{OUT}$ Accuracy at $T_A = -55^\circ C$ to $+125^\circ C$ , Post Rad	$V_{OUT} = 2.048V$ ( <a href="#">Note 10</a> )	-0.25		+0.25	%
TC $V_{OUT}$	Output Voltage Temperature Coefficient ( <a href="#">Note 8</a> )				<b>6</b>	ppm/ $^\circ C$
$V_{IN}$	Input Voltage Range	$V_{OUT} = 2.048V$	<b>4.2</b>		<b>30</b>	V
$I_{IN}$	Supply Current			0.3	<b>0.5</b>	mA
$\Delta V_{OUT}/\Delta V_{IN}$	Line Regulation	$V_{IN} = 4.2V$ to $30V$		0.3	<b>5</b>	ppm/V
$\Delta V_{OUT}/\Delta I_{OUT}$	Load Regulation	Sourcing: $0mA \leq I_{OUT} \leq 10mA$		11	<b>40</b>	ppm/mA
		Sinking: $-5mA \leq I_{OUT} \leq 0mA$		25	<b>80</b>	ppm/mA
$V_D$	Dropout Voltage ( <a href="#">Note 9</a> )	$I_{OUT} = 10mA$		2.0	<b>2.5</b>	V

**NOTES:**

- Compliance to datasheet limits is assured by one or more methods: production test, characterization and/or design.
- Over the specified temperature range. Temperature coefficient is measured by the box method whereby the change in  $V_{OUT}$  is divided by the temperature range; in this case,  $-55^\circ C$  to  $+125^\circ C = +180^\circ C$ .
- Dropout Voltage is the minimum  $V_{IN} - V_{OUT}$  differential voltage measured at the point where  $V_{OUT}$  drops 1mV from  $V_{IN} = \text{nominal}$  at  $T_A = +25^\circ C$ .
- The  $V_{OUT}$  accuracy is based on die mount with Silver Glass die attach material such as "QMI 2569" or equivalent in a package with an Alumina ceramic substrate.

## Total Dose Radiation Characteristics

This data is typical mean test data post total dose radiation exposure at both low dose rate (LDR) of <math><10\text{mrad(Si)/s}</math> to 50krads and at a high dose rate (HDR) of 50 to 300rad(Si)/s to 150krads. This data is intended to show typical parameter shifts due to low dose rate radiation. These are not limits nor are they guaranteed. LDR data to 150krads will be added when available.  $V_{IN} = 5\text{V}$ ,  $T_A = +25^\circ\text{C}$ ,  $I_{OUT} = 0$ ,  $C_{IN} = 0.1\mu\text{F}$ ,  $C_L = 1\mu\text{F}$  and  $C_{COMP} = 0.001\mu\text{F}$  unless otherwise specified.

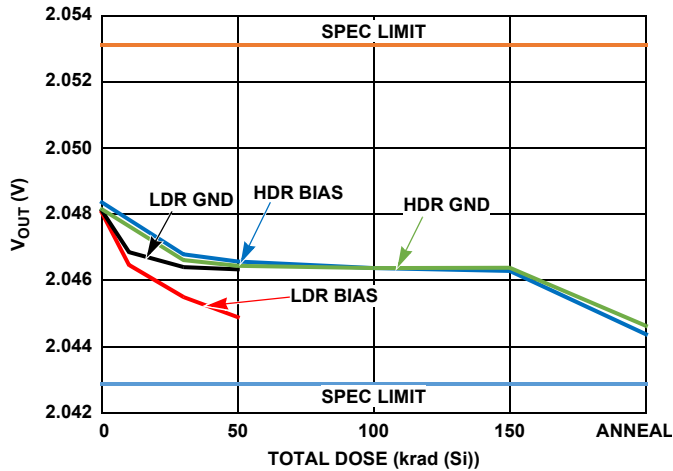

FIGURE 3.  $V_{OUT}$  ACCURACY SHIFT

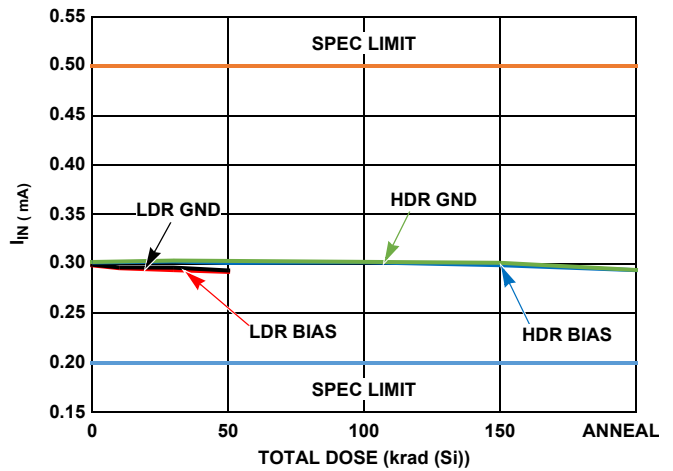

FIGURE 4. SUPPLY CURRENT SHIFT

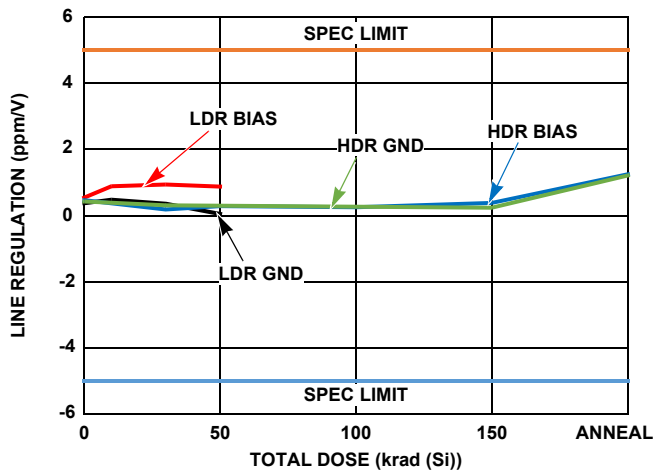

FIGURE 5. LINE REGULATION SHIFT

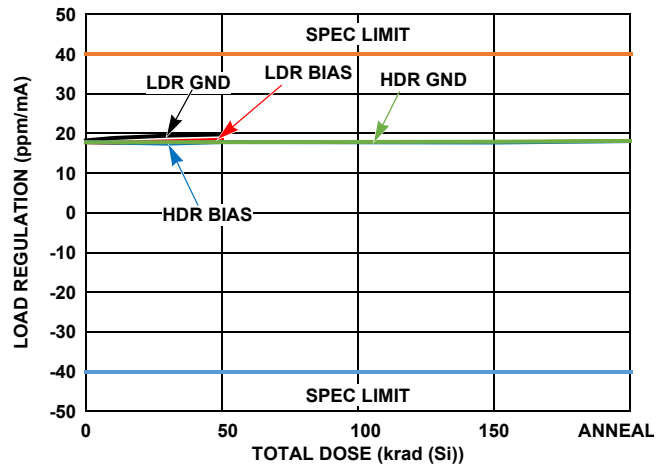

FIGURE 6. LOAD REGULATION (SOURCING) SHIFT

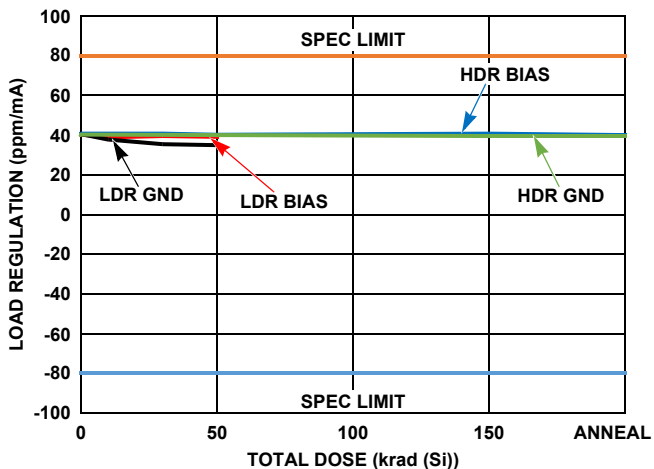

FIGURE 7. LOAD REGULATION (SINKING) SHIFT

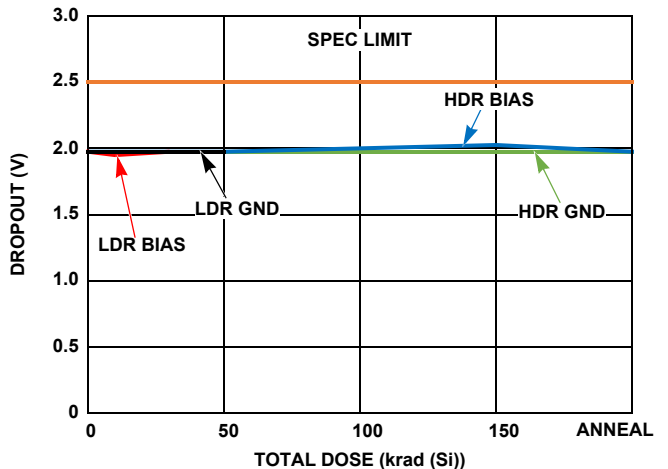

FIGURE 8. DROPOUT SHIFT

## Typical Performance Curves

$V_{IN} = 5V$ ,  $T_A = +25^\circ C$ ,  $I_{OUT} = 0$ ,  $C_{IN} = 0.1\mu F$ ,  $C_L = 1\mu F$  and  $C_{COMP} = 0.001\mu F$ , unless otherwise specified.

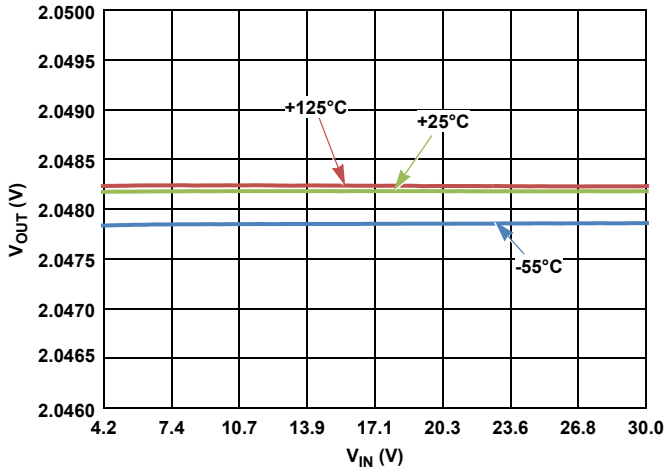

FIGURE 9. LINE REGULATION vs  $V_{OUT}$  (V) OVER-TEMPERATURE

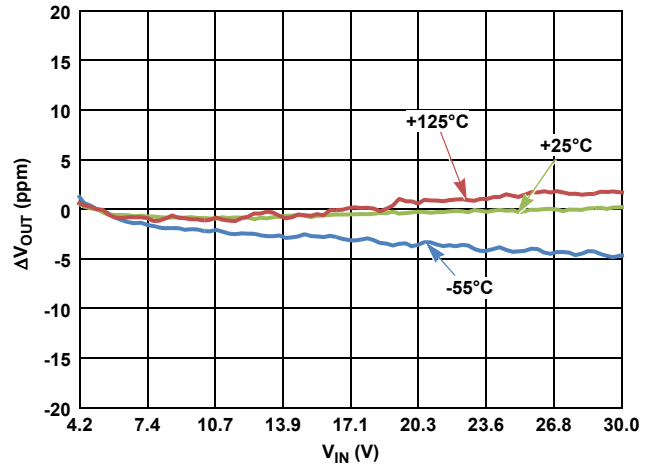

FIGURE 10. LINE REGULATION vs  $\Delta V_{OUT}$  (PPM) OVER-TEMPERATURE

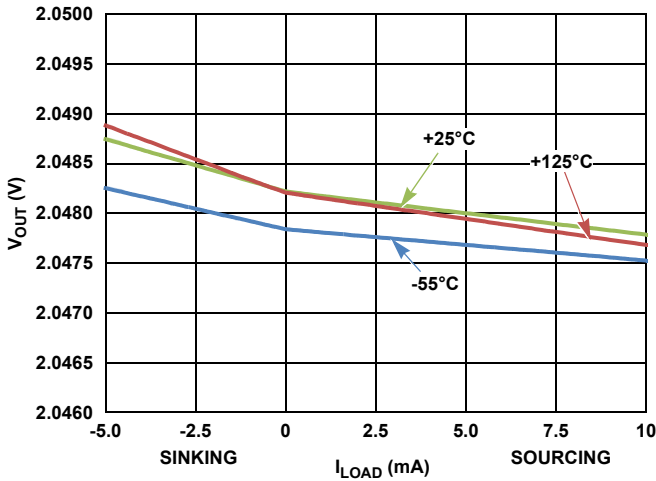

FIGURE 11. LOAD REGULATION vs  $V_{OUT}$  (V) OVER-TEMPERATURE

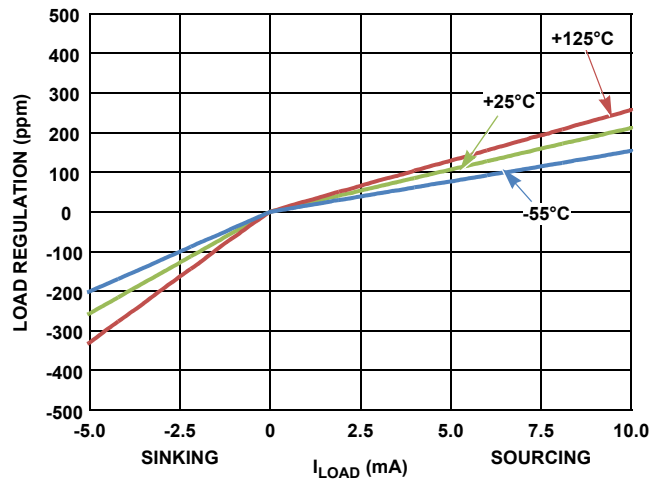

FIGURE 12. LOAD REGULATION vs  $V_{OUT}$  (PPM) OVER-TEMPERATURE

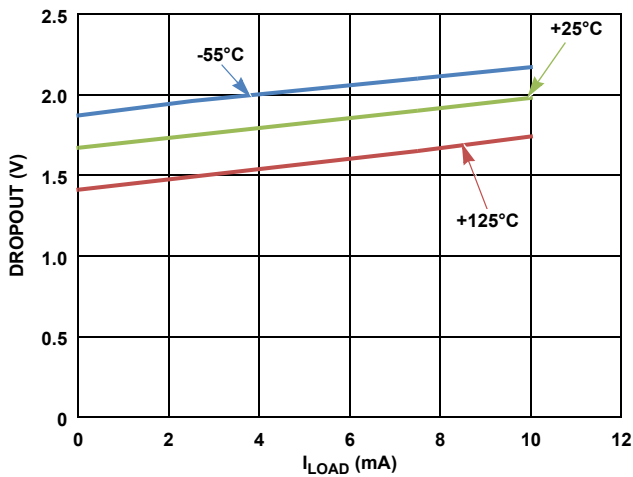

FIGURE 13. DROPOUT VOLTAGE vs OUTPUT CURRENT

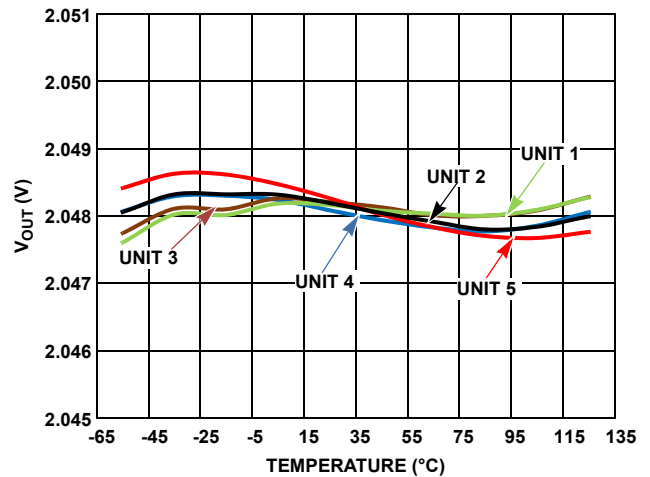

FIGURE 14.  $V_{OUT}$  vs TEMPERATURE

## Typical Performance Curves

$V_{IN} = 5V$ ,  $T_A = +25^\circ C$ ,  $I_{OUT} = 0$ ,  $C_{IN} = 0.1\mu F$ ,  $C_L = 1\mu F$  and  $C_{COMP} = 0.001\mu F$ , unless otherwise specified. (Continued)

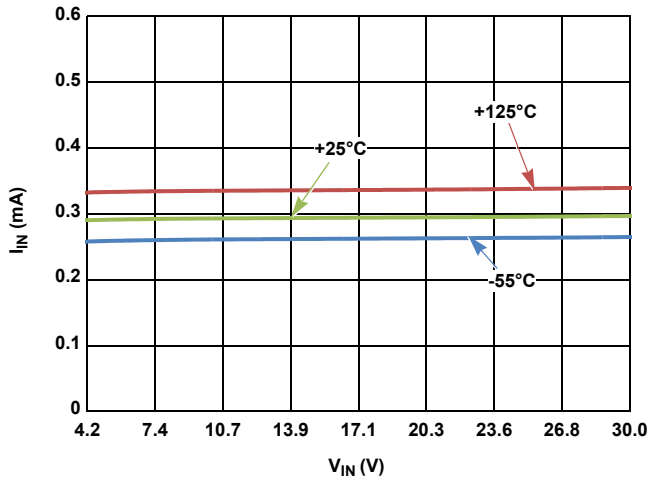

FIGURE 15.  $I_{IN}$  vs  $V_{IN}$  OVER-TEMPERATURE

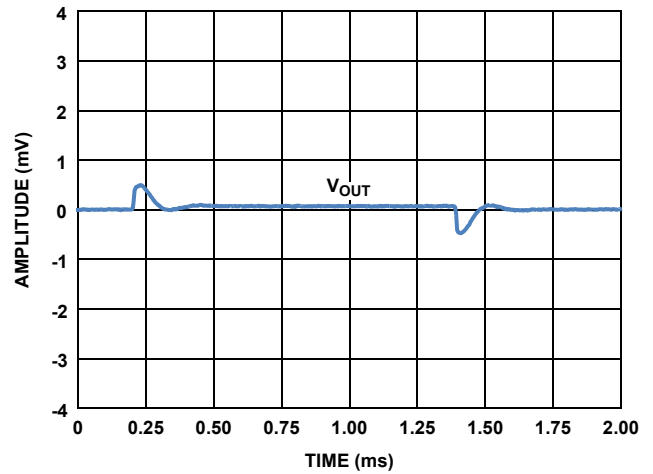

FIGURE 16. LINE TRANSIENT ( $\Delta V_{IN} = 500mV$ )

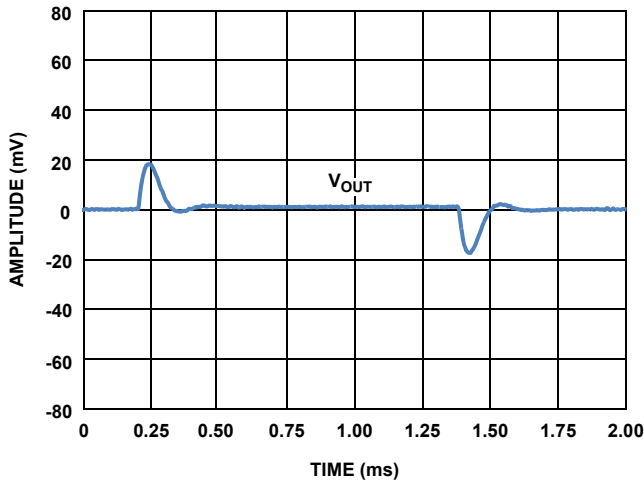

FIGURE 17. LOAD TRANSIENT ( $\Delta I_L = 1mA$ )

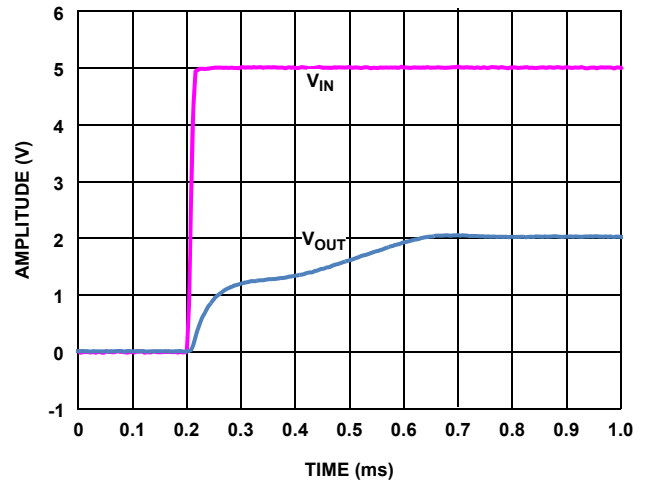

FIGURE 18. TURN-ON TIME

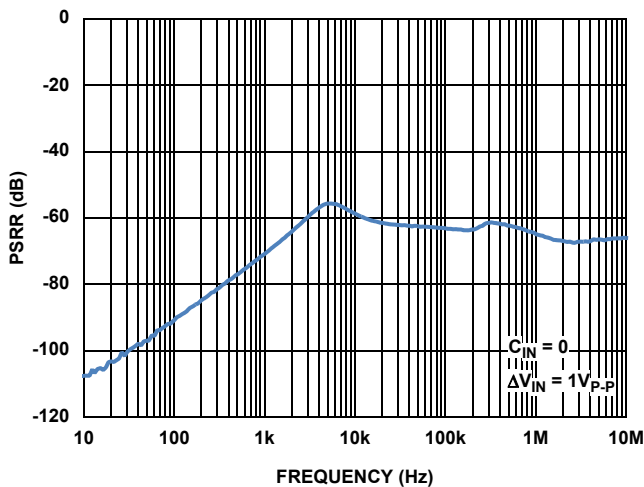

FIGURE 19. RIPPLE REJECTION vs FREQUENCY

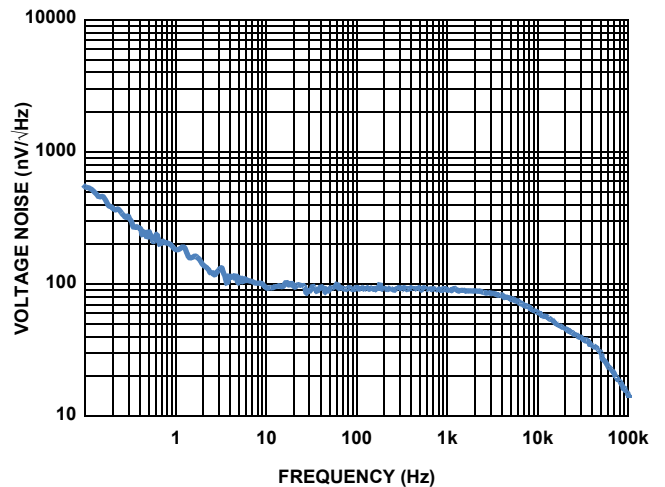

FIGURE 20. NOISE VOLTAGE DENSITY vs FREQUENCY



## Typical Performance Curves

$V_{IN} = 5V$ ,  $T_A = +25^\circ C$ ,  $I_{OUT} = 0$ ,  $C_{IN} = 0.1\mu F$ ,  $C_L = 1\mu F$  and  $C_{COMP} = 0.001\mu F$ , unless otherwise specified. (Continued)

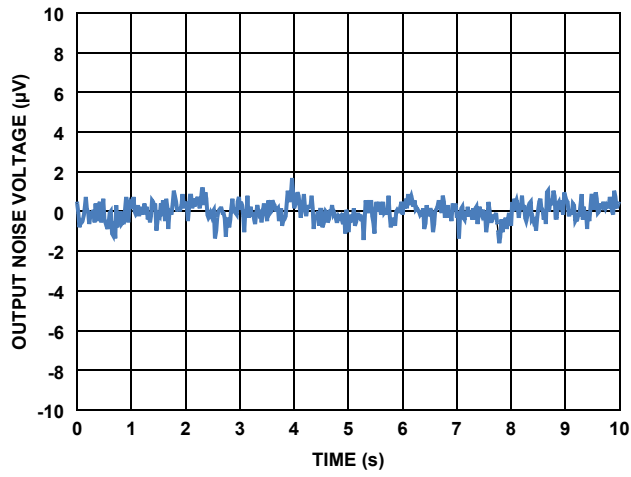

FIGURE 21.  $V_{OUT}$  vs NOISE, 0.1Hz TO 10Hz

## Device Operation

### Bandgap Precision References

The ISL71091SEH20 uses a bandgap architecture and special trimming circuitry to produce a temperature compensated, precision voltage reference with high input voltage capability and moderate output current drive.

## Applications Information

### Board Mounting Considerations

For applications requiring the highest accuracy, board mounting location should be reviewed. The device uses a ceramic flatpack package. Generally mild stresses to the die when the printed circuit (PC) board is heated and cooled, can slightly change the shape. Because of these die stresses, placing the device in areas subject to slight twisting can cause degradation of reference voltage accuracy. It is normally best to place the device near the edge of a board, or on the shortest side, because the axis of bending is most limited in that location. Mounting the device in a cutout also minimizes flex. Obviously, mounting the device on flexprint or extremely thin PC material will likewise cause loss of reference accuracy.

### Board Assembly Considerations

Some PC board assembly precautions are necessary. Normal output voltage shifts of 100 $\mu$ V to 500 $\mu$ V can be expected with Pb-free reflow profiles or wave solder on multi-layer FR4 PC boards. Precautions should be taken to avoid excessive heat or extended exposure to high reflow or wave solder temperatures.

### Noise Performance and Reduction

The output noise voltage in a 0.1Hz to 10Hz bandwidth is typically 3.8 $\mu$ V<sub>P-P</sub> ( $V_{OUT} = 2.048V$ ). The noise measurement is made with a bandpass filter. The filter is made of a 1-pole high-pass filter, with a corner frequency at 0.1Hz, and a 2-pole low-pass filter, with a corner frequency (3dB) at 9.9Hz, to create a filter with a 9.9Hz bandwidth. Noise in the 10Hz to 1kHz bandwidth is approximately 3.4 $\mu$ V<sub>RMS</sub> ( $V_{OUT} = 2.048V$ ), with 0.1 $\mu$ F capacitance on the output. This noise measurement is made with a 2 decade bandpass filter. The filter is made of a 1-pole high-pass filter with a corner frequency at 10Hz of the center frequency, and 1-pole low-pass filter with a corner frequency at 1kHz. Load capacitance up to 10 $\mu$ F can be added but will result in only marginal improvements in output noise and transient response.

### Turn-On Time

Normal turn-on time is typically 344 $\mu$ s, as shown in [Figure 18](#). The circuit designer must take this into account when looking at power-up delays or sequencing.

### Temperature Coefficient

The limits stated for temperature coefficient (Tempco) are governed by the method of measurement. The overwhelming standard for specifying the temperature drift of a reference is to measure the reference voltage at two temperatures, take the total variation, ( $V_{HIGH} - V_{LOW}$ ), and divide by the temperature extremes of measurement ( $T_{HIGH} - T_{LOW}$ ). The result is divided by the nominal reference voltage (at  $T = +25^{\circ}C$ ) and multiplied by

10<sup>6</sup> to yield ppm/ $^{\circ}C$ . This is the “Box” method for specifying temperature coefficient.

### Output Voltage Adjustment

The output voltage can be adjusted above and below the factory-calibrated value via the trim terminal. The trim terminal is the negative feedback divider point of the output op amp. The positive input of the amplifier is about 1.216V, and in feedback, so will be the trim voltage.

The suggested method to adjust the output is to connect a very high value external resistor directly to the trim terminal and connect the other end to the wiper of a potentiometer that has a much lower total resistance and whose outer terminals connect to  $V_{OUT}$  and ground. It is important to minimize the capacitance on the trim terminal to preserve output amplifier stability. It is also best to connect the series resistor directly to the trim terminal, to minimize that capacitance and also to minimize noise injection. Small trim adjustments, such as  $\pm 0.25\%$ , will not disturb the factory-set temperature coefficient of the reference, but trimming by large amounts can.

### Output Stage

The output stage of the device has a push-pull configuration with a high side PNP and a low side NPN. This helps the device to act as a source and sink. The device can source 10mA and sink 5mA.

### Use of COMP Capacitor

The reference can be compensated for the  $C_{OUT}$  capacitors used by adding a capacitor from the COMP pin to GND. See [Table 1](#) for recommended values of the COMP capacitor.

TABLE 1.

$C_{OUT}$ ( $\mu$ F)	$C_{COMP}$ (nF)
0.1	1
1	1
10	10

Data from SEE testing suggests the best option to use is 1 $\mu$ F for  $C_{OUT}$  and 1nF for  $C_{COMP}$ . Refer to the SEE report ([AN1938](#)) for more details.

### DNC Pins

These pins are for trimming purpose and for factory use only. Do not connect these to the circuit in any way. It will adversely effect the performance of the reference.

### Simulation Model

A SPICE simulation model is available under the Documents tab of the [ISL71091SEH20](#) landing page on the Intersil website. [Figures 22](#) through [27](#) show a comparison of the characterized part performance and the simulated part performance.

## Characterization vs Simulation Results

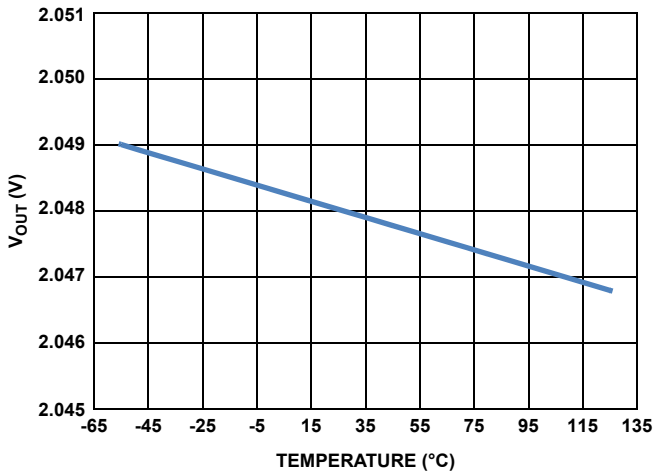

FIGURE 22. SIMULATED (WORSE CASE)  $V_{OUT}$  vs TEMPERATURE

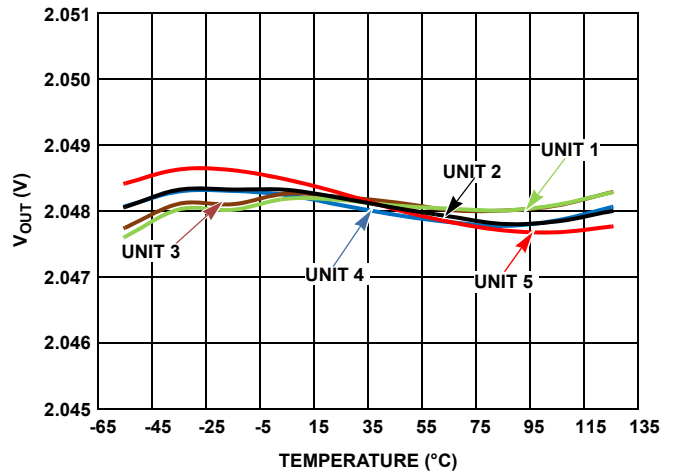

FIGURE 23. CHARACTERIZED  $V_{OUT}$  vs TEMPERATURE

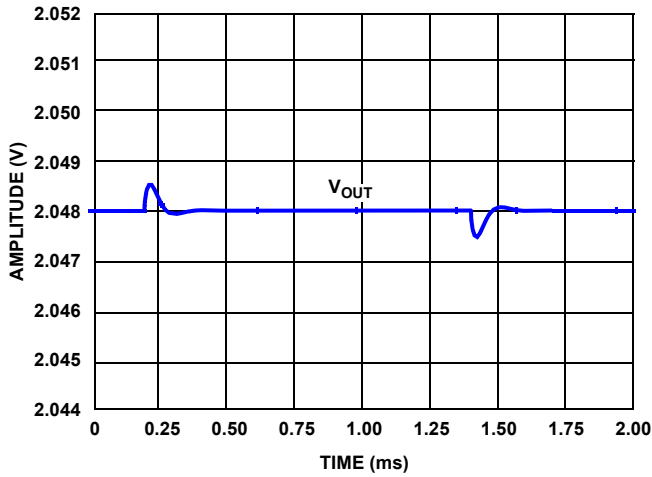

FIGURE 24. SIMULATED LINE TRANSIENT ( $\Delta V_{IN} = 500\text{mV}$ )

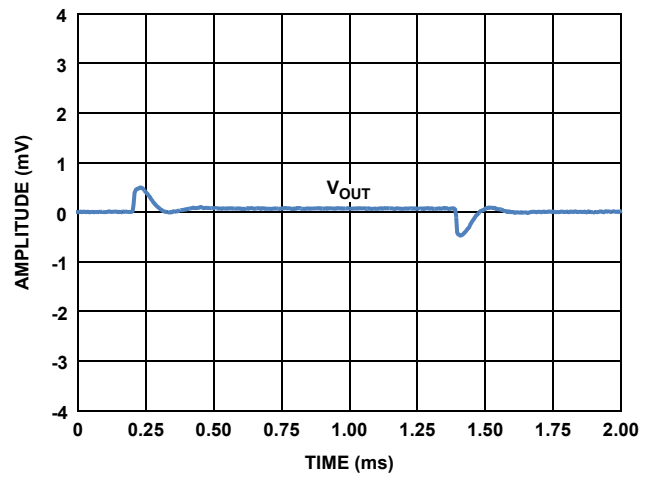

FIGURE 25. CHARACTERIZED LINE TRANSIENT ( $\Delta V_{IN} = 500\text{mV}$ )

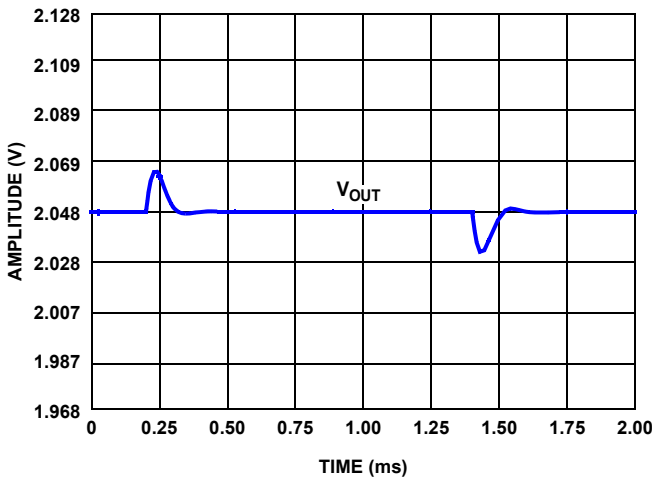

FIGURE 26. SIMULATED LOAD TRANSIENT ( $\Delta I_L = 1\text{mA}$ )

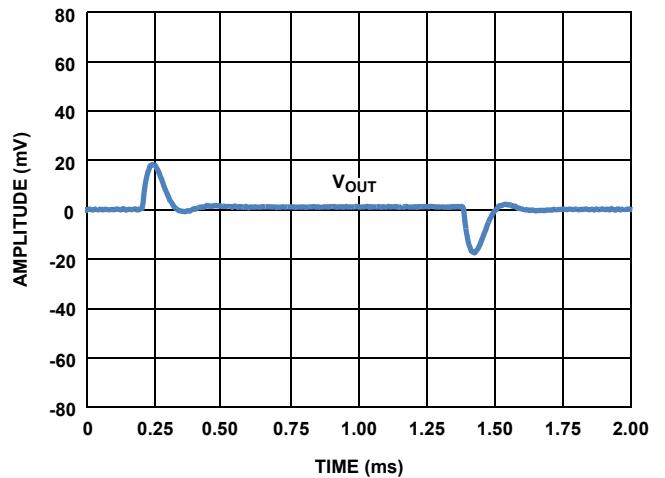

FIGURE 27. CHARACTERIZED LOAD TRANSIENT ( $\Delta I_L = 1\text{mA}$ )

# ISL71091SEH20

## Package Characteristics

### Weight of Packaged Device

0.31 Grams (Typical)

### Lid Characteristics

Finish: Gold

Potential: Connected to Pin #4 (GND)

Case Isolation to Any Lead:  $20 \times 10^9 \Omega$  (min)

## Die Characteristics

### Die Dimensions

$1990\mu\text{m} \times 2380\mu\text{m}$  (78 mils  $\times$  94 mils)

Thickness:  $483\mu\text{m} \pm 25\mu\text{m}$  (19 mils  $\pm$  1 mil)

### Interface Materials

#### GLASSIVATION

Type: Nitrox

Thickness:  $15\text{k}\text{\AA}$

### TOP METALLIZATION

Type: AlCu (99.5%/0.5%)

Thickness:  $30\text{k}\text{\AA}$

### BACKSIDE FINISH

Silicon

## ASSEMBLY RELATED INFORMATION

### SUBSTRATE POTENTIAL

Floating

## ADDITIONAL INFORMATION

### WORST CASE CURRENT DENSITY

$<2 \times 10^5 \text{ A/cm}^2$

### PROCESS

Dielectrically Isolated Advanced Bipolar Technology- PR40

## Metallization Mask Layout

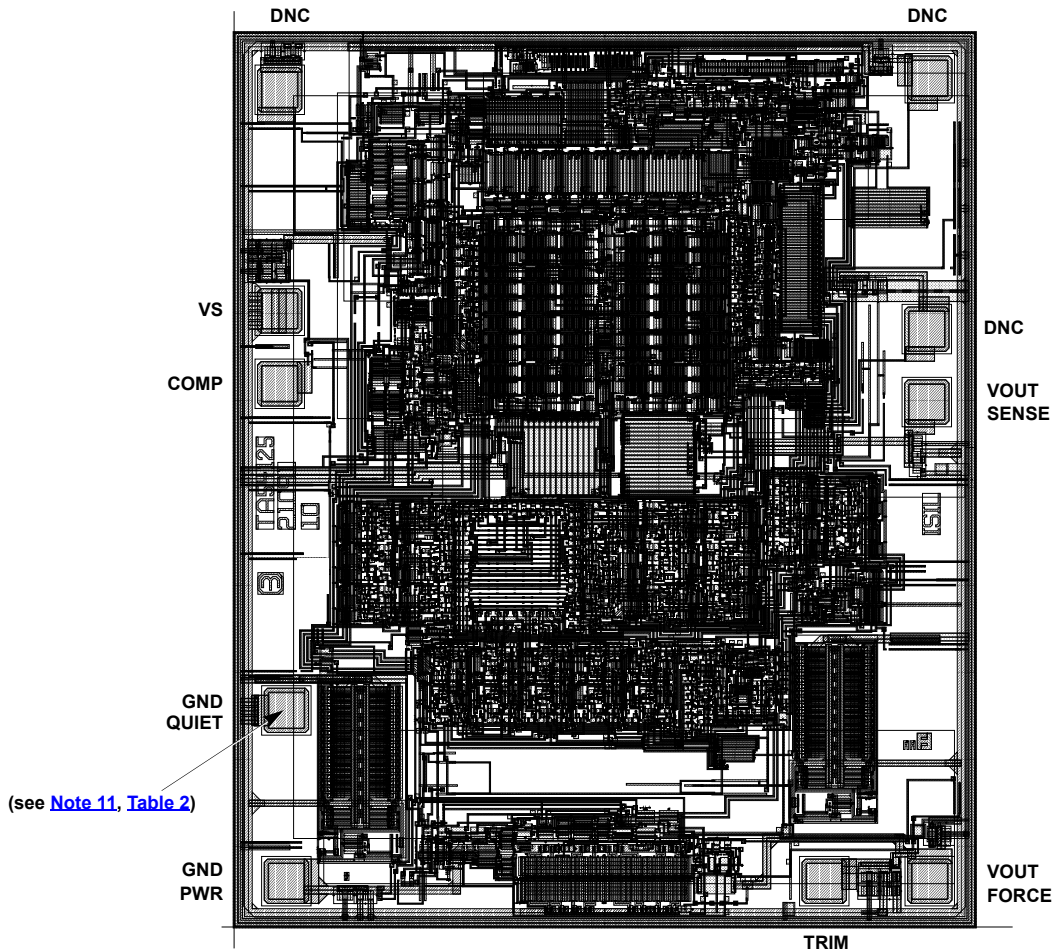

# ISL71091SEH20

TABLE 2. DIE LAYOUT X-Y COORDINATES

PAD NAME	PAD NUMBER	X ( $\mu\text{m}$ )	Y ( $\mu\text{m}$ )	BOND WIRES PER PAD ( <a href="#">Note 12</a> )
GND PWR	1	1	-436	1
GND QUIET	2	0	0	1
COMP	3	-15	831	1
VS	4	-17	1018	1
DNC	5			
DNC	6			
DNC	7			
VOUT SENSE	8	1633	786	1
VOUT FORCE	9	1640	-436	1
TRIM	10	1505	-436	1

NOTES:

11. Origin of coordinates is the centroid of GND QUIET.
12. Bond wire size is 1 mil.

## Revision History

The revision history provided is for informational purposes only and is believed to be accurate, but not warranted. Please go to web to make sure you have the latest revision.

DATE	REVISION	CHANGE
July 11, 2014	FN8632.1	Page 1 - changed title from: "Radiation Hardened Ultra Low Noise, Precision Voltage Reference" to: "2.048V Radiation Hardened Ultra Low Noise, Precision Voltage Reference"
May 28, 2014	FN8632.0	Initial Release.

## About Intersil

Intersil Corporation is a leading provider of innovative power management and precision analog solutions. The company's products address some of the largest markets within the industrial and infrastructure, mobile computing and high-end consumer markets.

For the most updated datasheet, application notes, related documentation and related parts, please see the respective product information page found at [www.intersil.com](http://www.intersil.com).

You may report errors or suggestions for improving this datasheet by visiting [www.intersil.com/ask](http://www.intersil.com/ask).

Reliability reports are also available from our website at [www.intersil.com/support](http://www.intersil.com/support)

For additional products, see [www.intersil.com/en/products.html](http://www.intersil.com/en/products.html)

Intersil products are manufactured, assembled and tested utilizing ISO9001 quality systems as noted in the quality certifications found at [www.intersil.com/en/support/qualandreliability.html](http://www.intersil.com/en/support/qualandreliability.html)

*Intersil products are sold by description only. Intersil Corporation reserves the right to make changes in circuit design, software and/or specifications at any time without notice. Accordingly, the reader is cautioned to verify that data sheets are current before placing orders. Information furnished by Intersil is believed to be accurate and reliable. However, no responsibility is assumed by Intersil or its subsidiaries for its use; nor for any infringements of patents or other rights of third parties which may result from its use. No license is granted by implication or otherwise under any patent or patent rights of Intersil or its subsidiaries.*

For information regarding Intersil Corporation and its products, see [www.intersil.com](http://www.intersil.com)

## Package Outline Drawing

### K8.A

8 LEAD CERAMIC METAL SEAL FLATPACK PACKAGE

Rev 3, 3/13

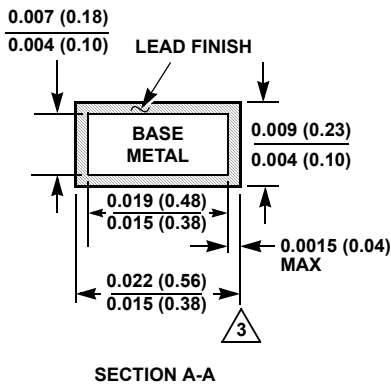
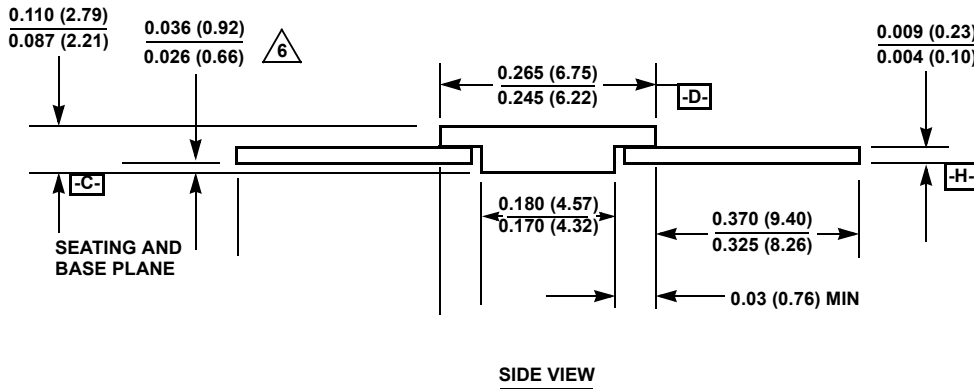
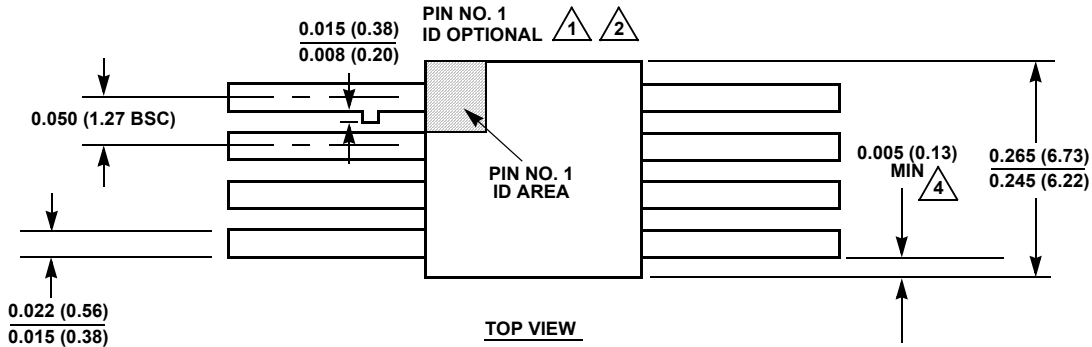

#### NOTES:

1. Index area: A notch or a pin one identification mark shall be located adjacent to pin one and shall be located within the shaded area shown. The manufacturer's identification shall not be used as a pin one identification mark. Alternately, a tab may be used to identify pin one.
2. If a pin one identification mark is used in addition to a tab, the limits of the tab dimension do not apply.
3. The maximum limits of lead dimensions (section A-A) shall be measured at the centroid of the finished lead surfaces, when solder dip or tin plate lead finish is applied.
4. Measure dimension at all four corners.
5. For bottom-brazed lead packages, no organic or polymeric materials shall be molded to the bottom of the package to cover the leads.
6. Dimension shall be measured at the point of exit (beyond the meniscus) of the lead from the body. Dimension minimum shall be reduced by 0.0015 inch (0.038mm) maximum when solder dip lead finish is applied.
7. Dimensioning and tolerancing per ANSI Y14.5M - 1982.
8. Controlling dimension: INCH.